

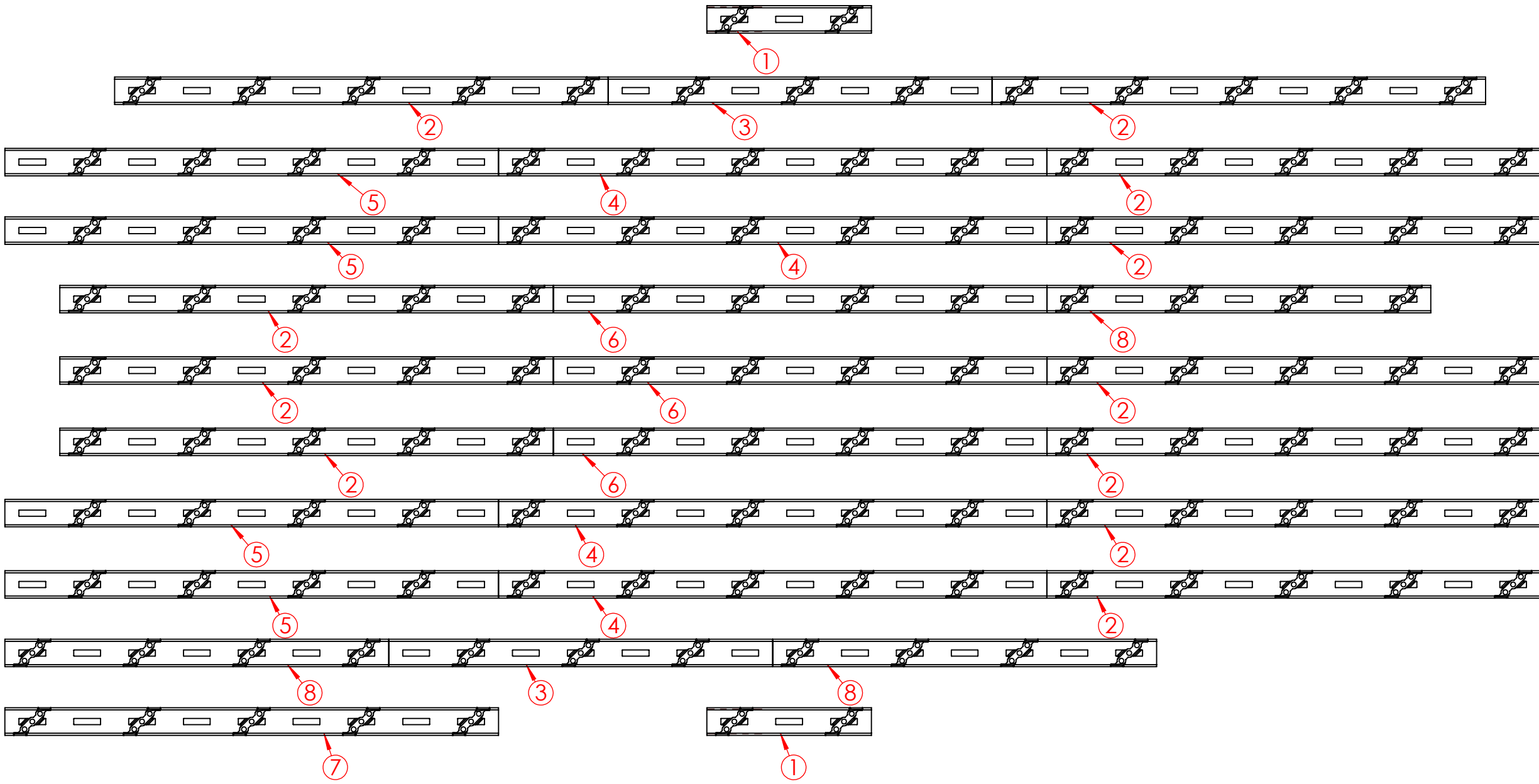

REVISION					
REV.	DESCRIPTION	DRAWN BY	DATE	APPROVED BY	DATE
A	INITIAL RELEASE	K.PARKS	10/27/23		

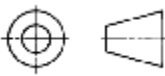









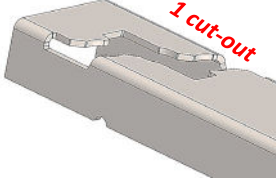

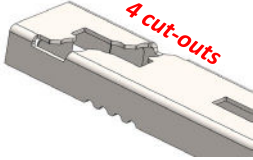

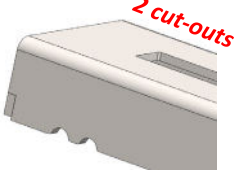

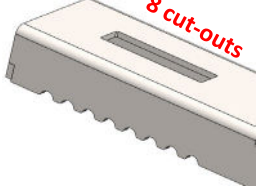
NOTE: REFERENCE CAD MODEL FOR ALL UNDIMENSIONED FEATURES

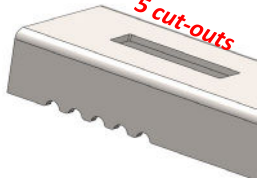
ITEM NO.	PART NUMBER	DESCRIPTION	QTY.
1	XTR015XP-XW	15" ABILITRAX RAIL WELDMENT	2
2	XTR045XP-XAW	45" ABILITRAX RAIL WELDMENT W/ ONE SPLICE	11
3	XTR035XP-XAW	35" ABILITRAX RAIL WELDMENT TWO SPLICE	2
4	XTR050XP-XAW	50" ABILITRAX RAIL WELDMENT W/ TWO SPLICE	4
5	XTR045XP-XBW	45" ABILITRAX RAIL W/ ONE SPLICE	4
6	XTR045XP-XDW	45" ABILITRAX RAIL WELDMENT W/ TWO SPLICE	3
7	XTR045XP-XW	45" ABILITRAX RAIL WELDMENT NO SPLICE	1
8	XTR035XP-XBW	35" ABILITRAX RAIL WELDMENT ONE SPLICE	3

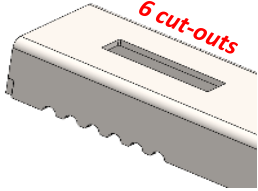
<b>GAUGE:</b> 10	<b>PART NUMBER:</b> AAT40000LRK	<b>REV</b> A
<b>MATERIAL:</b> GRADE 50	<b>DESCRIPTION:</b> TRANSIT 140 LASER RAIL KIT	
<b>FINISH:</b> PLATING	 	
<b>TOLERANCES (UNLESS OTHERWISE NOTED)</b> <b>FABRICATED:</b> ANGULAR: ± 1° TWO PLACE DECIMAL: ± 0.03 THREE PLACE DECIMAL: ± 0.02 <b>MACHINED:</b> ANGULAR: ± 0.5° TWO PLACE DECIMAL: ± 0.01 THREE PLACE DECIMAL: ± 0.005		
<b>APPLICABLE TOLERANCE:</b> FABRICATED	<b>SCALE:</b> 1:11	<b>SHEET:</b> 1 OF 1

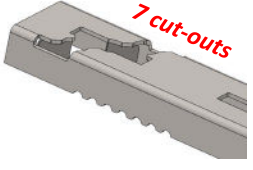
# RAIL I.D CHART

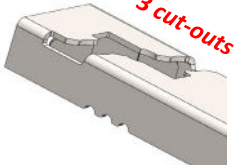
DOCUMENT PREVIEW	ID MARK	PART NUMBER	DESCRIPTION
		XTR015XP-XW	15" ABILITRAX RAIL WELDMENT
		XTR045XP-XAW	45" ABILITRAX RAIL WELDMENT ONE SPLICE (X-TRACK BOTH ENDS)
		XTR035XP-XW	35" ABILITRAX RAIL WELDMENT TWO SPLICE
		XTR050XP-XAW	50" ABILITRAX RAIL WELDMENT TWO SPLICE
		XTR045XP-XBW	45" ABILITRAX RAIL WELDMENT ONE SPLICE
		XTR045XP-XDW	45" ABILITRAX RAIL WELDMENT TWO SPLICE
		XTR045XP-XW	45" ABILITRAX RAIL WELDMENT NO SPLICE
		XTR035XP-XBW	35" ABILITRAX RAIL WELDMENT ONE SPLICE